

britax

ECO
TOY
BOX

Kiosk

Materials

1 Cardboard Box
(from your Britax car seat)

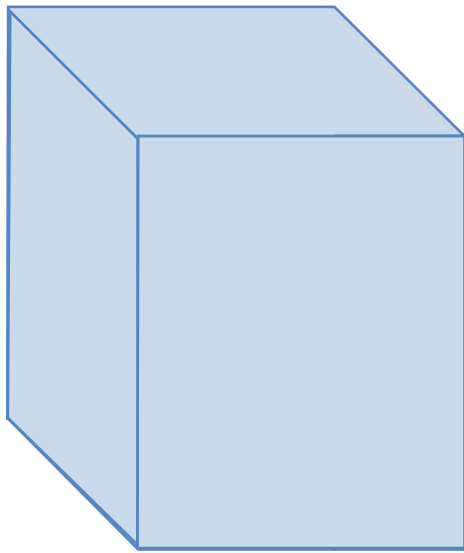

Scissors or
Box Cutter

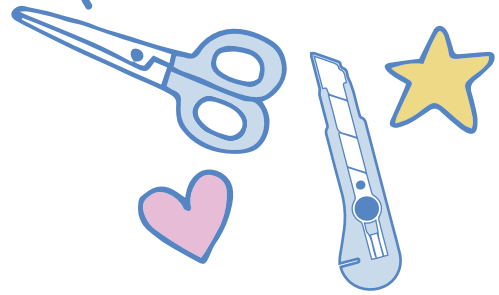

Ruler

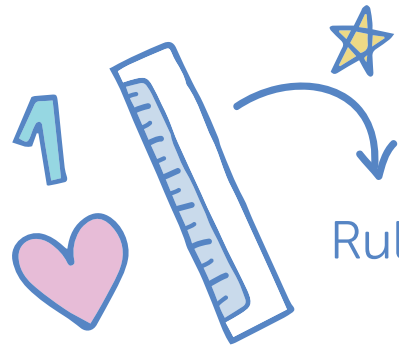

Glue



2

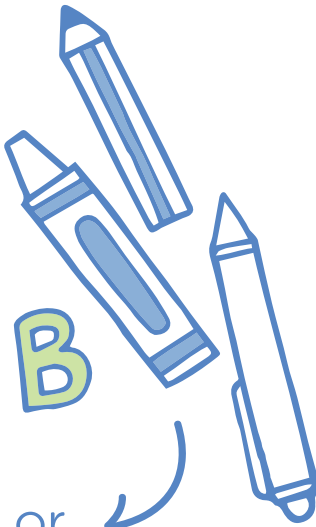

1 plate for outlining

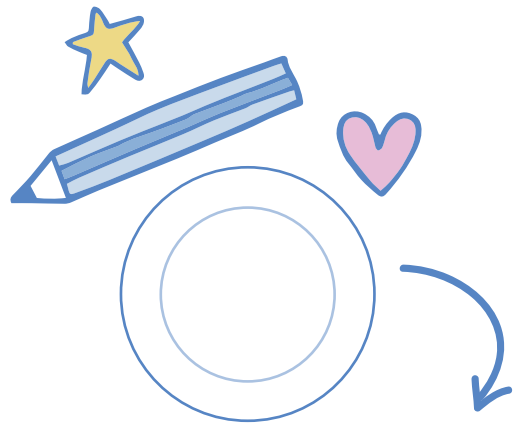

Pencils, crayons, paint or
other materials for decorating

How To Make A Shop Using A Britax Cardboard Box



1

Take the Britax box and put it on a table to work comfortably. Close the 4 flaps of the box. A pair of flaps (the ones that come together) will define half of the box. Take that half as a reference and draw a line along the sides of the box. Then, very carefully with a box cutter and a ruler, cut the box into 2 equal halves.

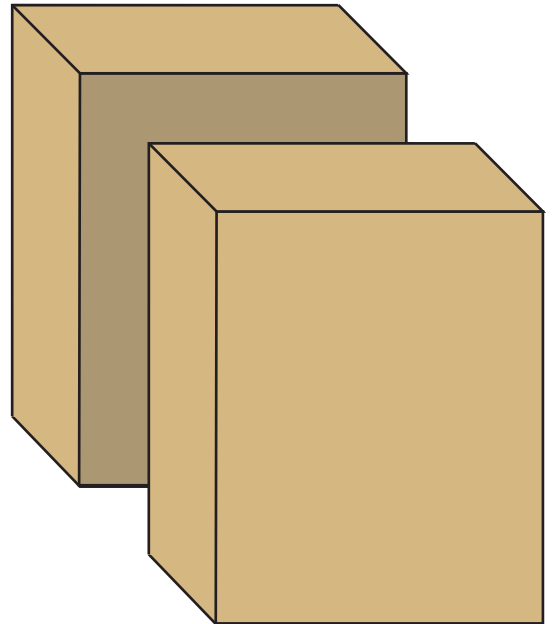
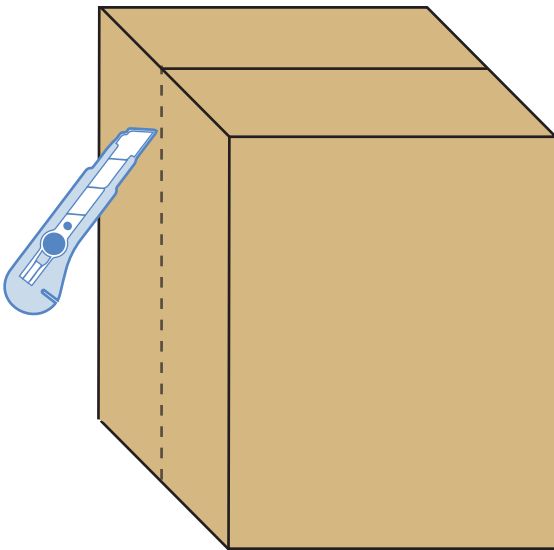
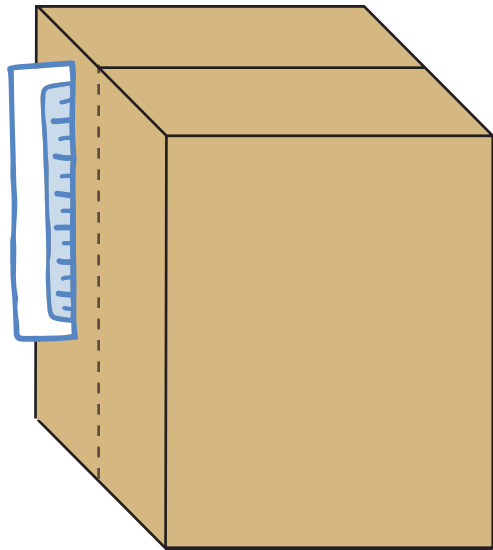
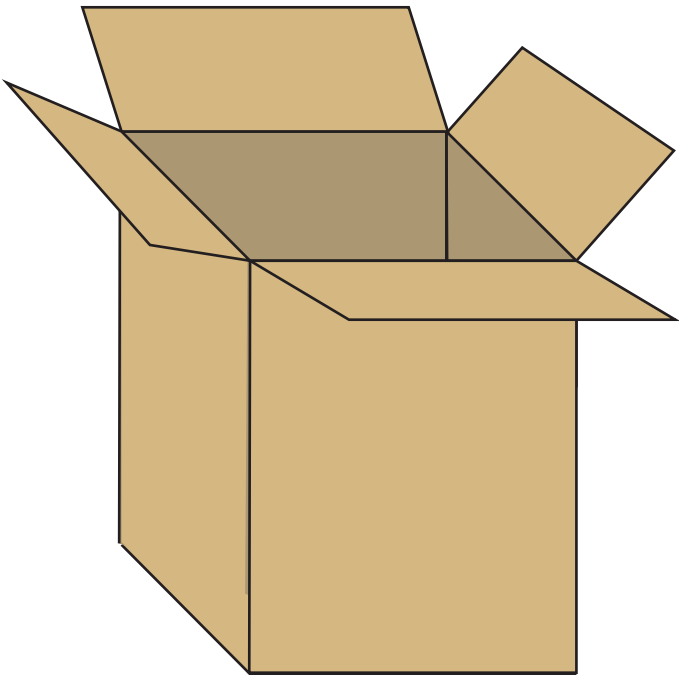

2

For the first half, glue the flaps of each side, as shown in the figure.

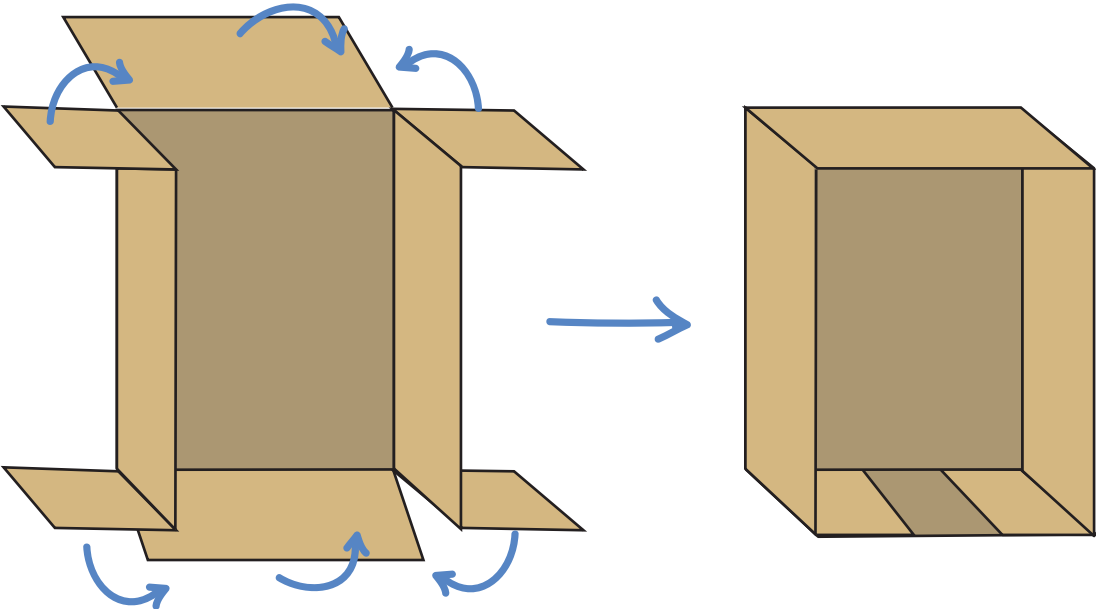

3

For the second half, extend the upper flaps and measure 4 in from the edge. Make a half-cut with cardboard knife. Fold the three half-cuts inward. Glue the two side flaps to the top flap.

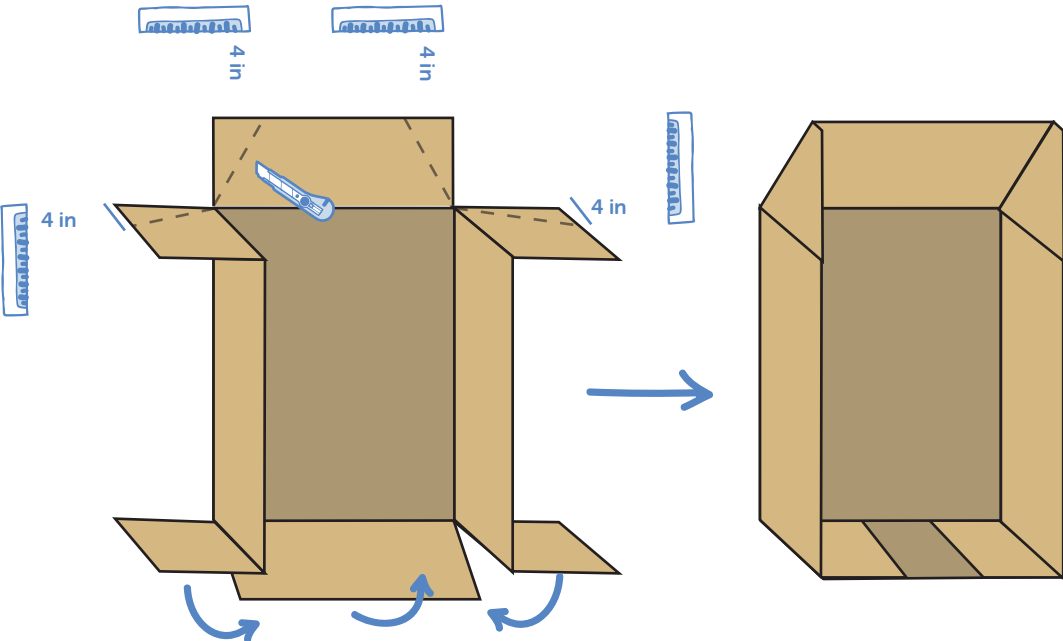

4

Put half one on top of half two and join them with glue.

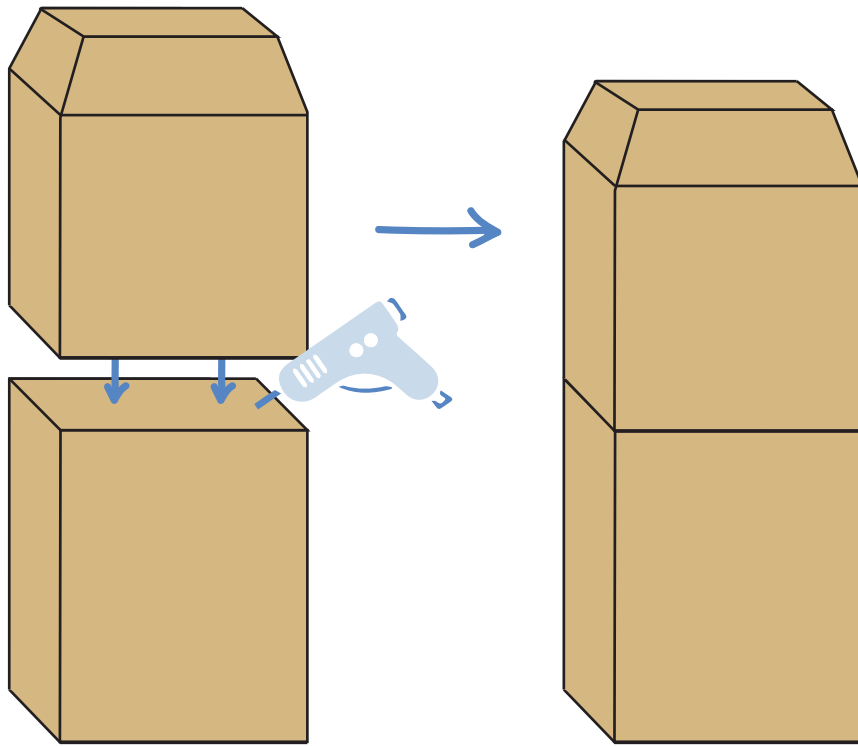

5

In the upper half, measure 10 cm on the sides, make a line. Use a plate to draw the circles that will be the roof of the kiosk. Then, very carefully, cut with the box cutter.

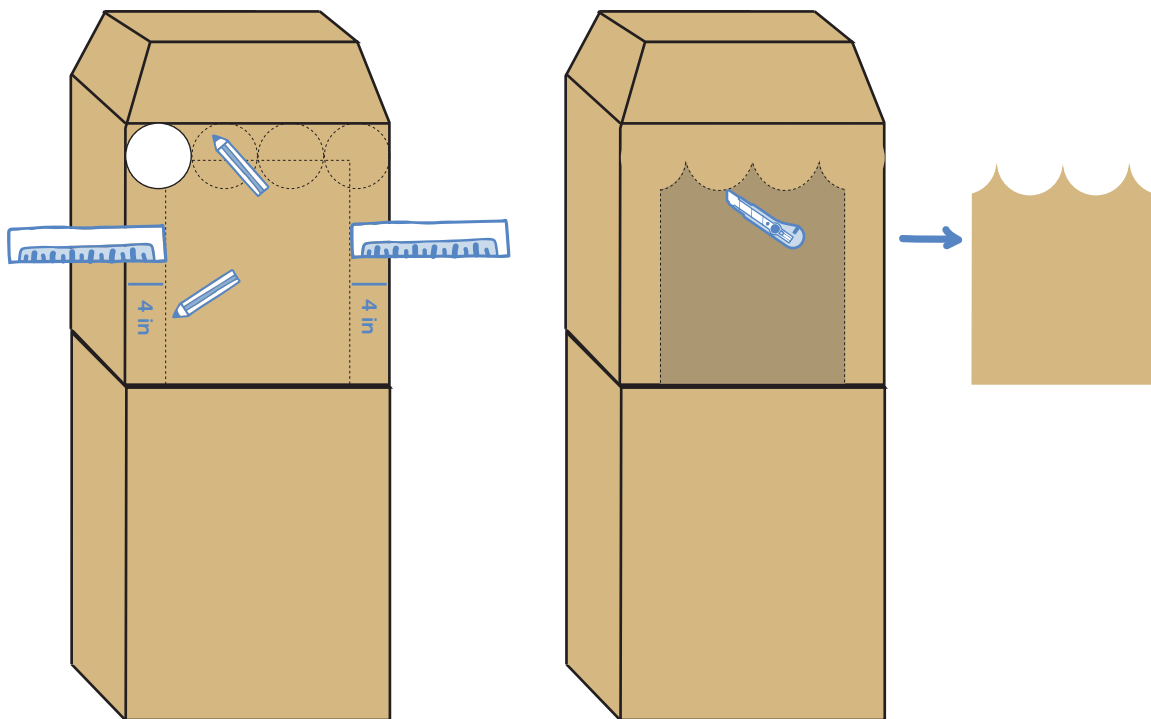



It's time to decorate! With pencils, crayons, papers, paint or whatever you have at home add color as you'd like!

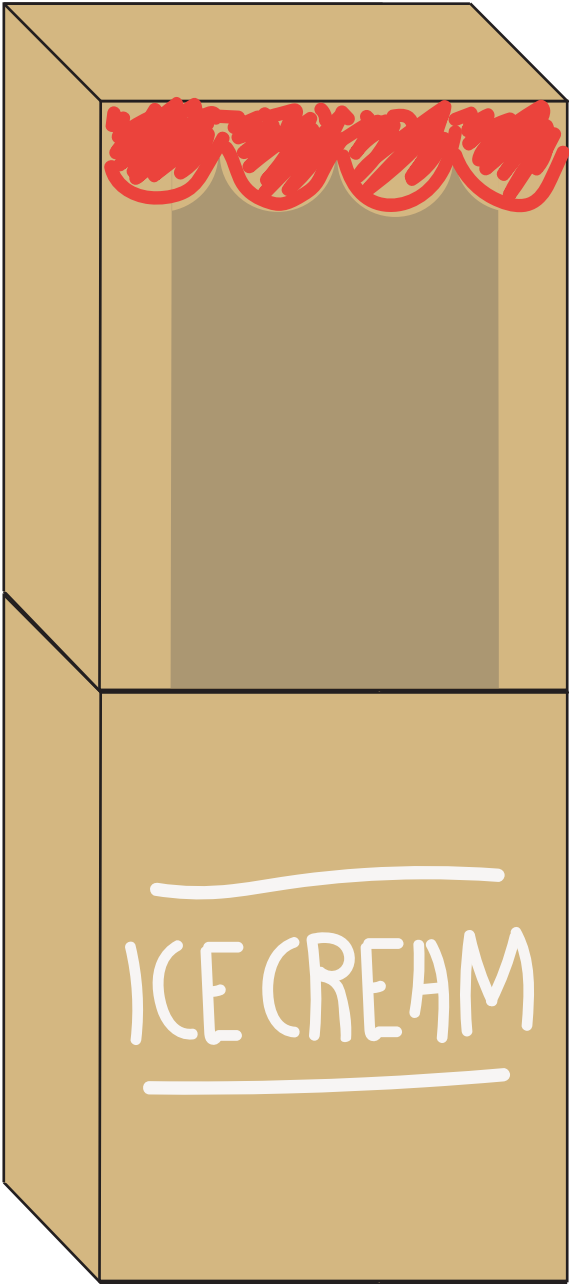

That's how easy it is to create a kiosk with recycled material from Britax boxes!